

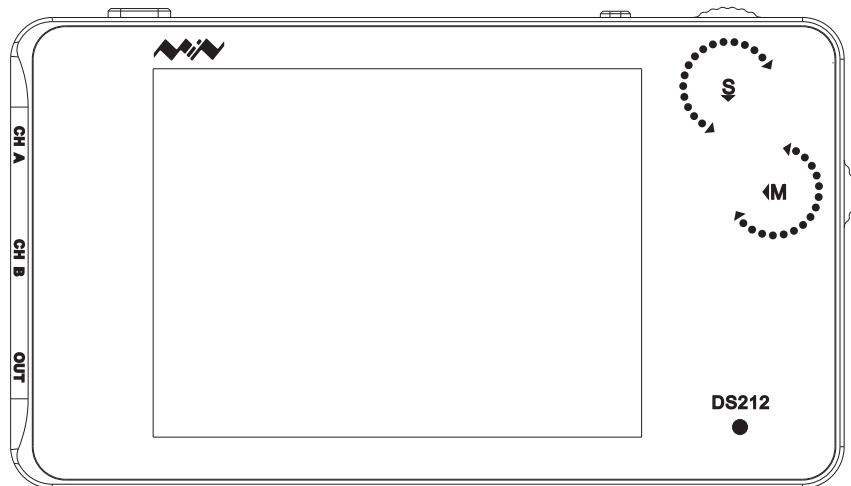

DS212 Mini Oscilloscope

User Manual

Version 1.0



Contents

Important Safety Information	P1
Chapter 1 DS212 Overview	P2
Chapter 2 Interface Introduction	P5
Chapter 3 Getting Started	P8
Chapter 4 Functional Overview	P13
Chapter 5 Product Inspection	P20
Chapter 6 Battery Disposal	P21
Chapter 7 Technical Support	P22

This user manual is
based on APP V1.03



Warning: Warning statements identify conditions or practices that could result in injure yourself or others.



Caution: Caution statements identify conditions or practices that could result in damage to your device or other property.



Attention: Attention statements identify annotations, usage tips or additional information.

Safety Statement

General Safety Information



- Read carefully all the following safety precautions to avoid personal injury and prevent damage to the device or any products connected to it. Failure to follow these safety instructions could result in personal injuries or risk of fire.



- **Use proper power cord.** Please use power cord specified for this product and certified for your country/district of use.
- **Connect and disconnect properly.** Do not connect or disconnect probe or test leads while they are connected to voltage source. Before you connect or disconnect current probes, please disconnect power to the circuit under test.
- **Observe all the terminal ratings.** To avoid fire or shock hazard, please do not measure signals at DC40V or above. Please read the User Manual carefully to learn more about ratings before connection.



- Do not operate in a humid environment.
- Do not operate in a potentially inflammable/explosive atmosphere.
- Please keep the device surface clean and dry.

Operating Environment

Operating Environment	Requirement
Temperature	Operating Condition: +0°C to 50°C
	Non-operating Condition: -20°C to +60°C
Humidity	Operating Condition: High Temperature : 40°C to 50°C, 0% to 90%RH
	Low Temperature : 0°C to 40°C, 10% to 90%RH
	Non-operating Condition: High temperature : 40°C to 60°C, 5% to 95%RH
	Low temperature : 0°C to 40°C, 5% to 95%RH

DS212 Overview

Specifications

Performance parameters

Coupling	AC/DC
Analog bandwidth	1MHz
Maximum sampling rate	10MSa/s
Analog input impedance	1M Ω
Maximum input voltage	$\pm 40V$ (X1 probe)
Maximum sample memory depth	8K
Horizontal sensitivity	1uS/Div~2S/Div(in 1-2-5 sequence step)
Vertical sensitivity	20mv/Div~10V/Div (in 1-2-5 sequence step)



Functionalities

Modes	Vertical precise, horizontal precise measurement and trigger threshold
Trigger mode	Rising/Falling edge trigger
Synchronous mode	Auto, Normal, Single, None, Scan
Auto measurement	frequency, cycle time, duty cycle, DC RMS voltage/ Vpp /Vmax/Vmin/Vavg
Inbuilt signal Generator	10Hz~1MHz square wave (duty adjustable) or 10Hz~20KHz Sine/ Square/Triangle/Sawtooth wave

Product parameters

Storage	Inbuilt 8MB U disk storage for waveform data and images
Dimension	(100mm×56.5mm×10mm)
Battery	Internal 500mAh Lithium battery, external USB port
Display	Color TFT LCD display (320X240 pixels)

DS212 Overview

Interface & Buttons

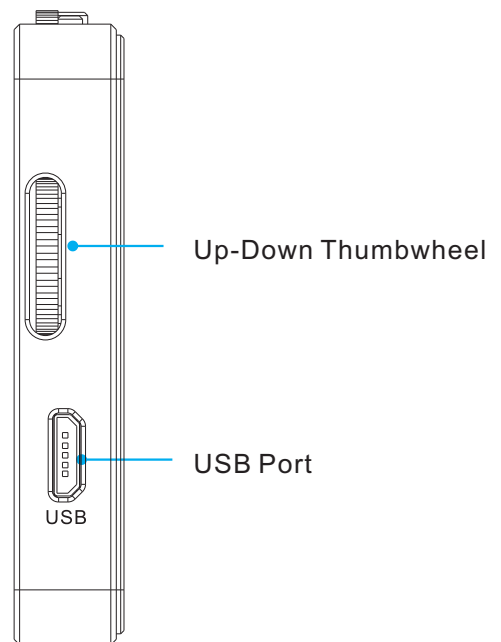
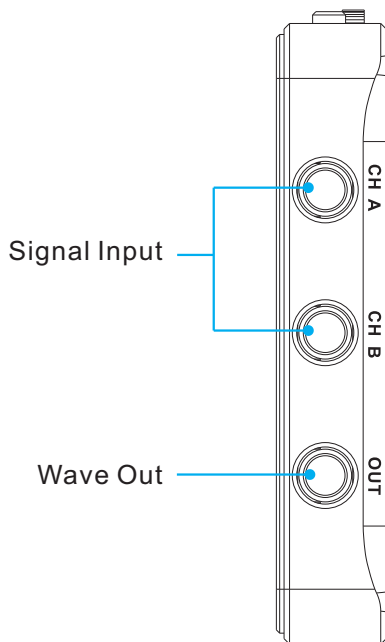
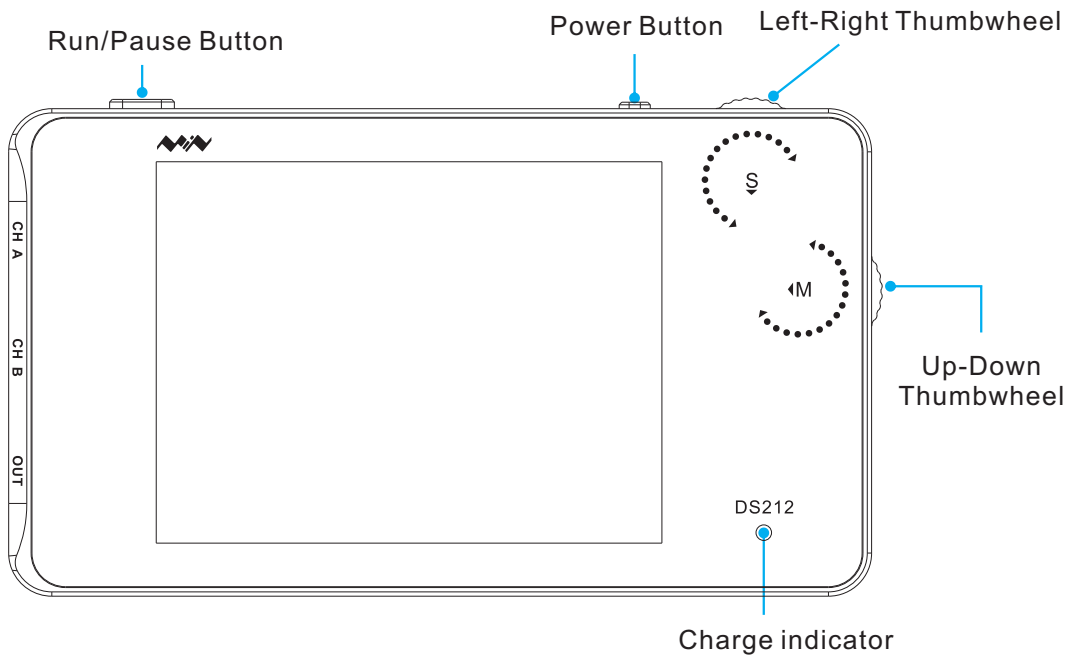

DS212 Overview

Operation on option area

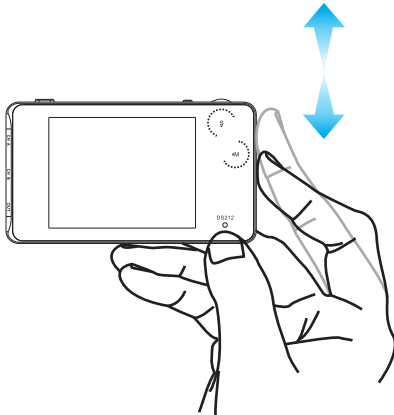

Dial Up/Down

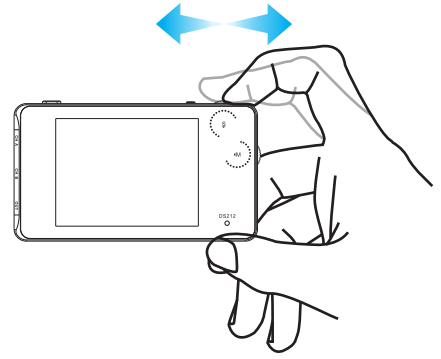

Dial Left/Right

Button	Function
	1)Click:Run/Pause 2)long press:Save current parameter/screen display
Wheel M	(Dial Up/Down) Choose up/down
Wheel M middle button	1)Click:Sub-menu On/Off 2)long press:Enter file management 3)Double click:When "Auto Fit" is ON, auto adjustment
Wheel S	Dial left/right to increase/decrease the setting parameters
Wheel S middle button	1)Click:Switch Menu/Confirm sub-menu 2)long press:Menu display/hide



Note that each item's color in Parameter Area is the same as that in Measurement Area.

Interface Introduction

Home screen introduction

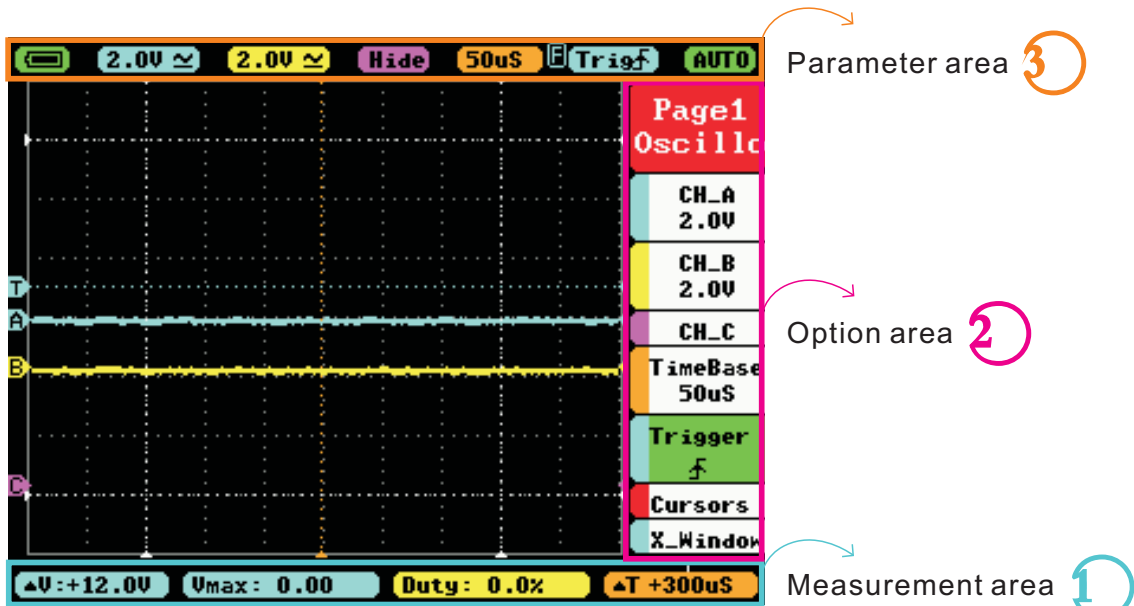

Home screen



Measurement area introduction

ΔV: +6.00V Freq: 0.00Hz Duty: 0.0% ΔT +120uS

Menu	Function
ΔV: +6.00V	$\Delta V = V1 - V2$
Freq: 0.00Hz	Measured Value (Blue corresponds with Channel A, Yellow with Channel B) corresponding the 1st and 2nd item in Page2
Duty: 0.0%	
ΔT +120uS	$\Delta T = T2 - T1$

Interface Introduction

Home screen introduction



Option area introduction

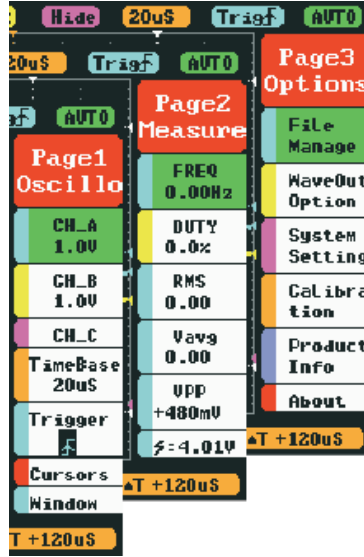

Page1(oscilloscope)

- A channel option
- Bchannel option
- C channel option
- TimeBase option
- Trigger option
- Vernier option
- Horizontal window

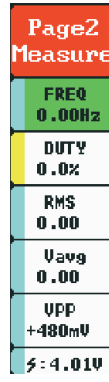

Page2(Measurement)

- Frequency
- Duty ratio
- root-mean-square value
- voltage average value
- voltage peak-to-peak value
- battery voltage



Page3(option)

- File management
- Output option
- System settings
- Adjusting option
- Product information
- relevant information



Annotation: detailed introduction to options refer to Page 13-19

Interface Introduction

Home screen introduction

3

Parameter area introduction



Menu	Item	Functions
	/ /	Battery supply/USB charging/Full charge
	20mV—10V(1-2-5 sequence step) AC/DC	(Channel A) y-axis voltage per grid, AC/ DC coupling method
	20mV—10V(1-2-5 sequence step) AC/DC	(Channel B) y-axis voltage per grid, AC/ DC coupling
	(-A)/(-B)/(A+B)/(A-B)/ RecA/RecB/RecC/Hide	(-A):Ch_A waveform reverses (-B): Ch_B waveform reverses (A+B): Ch_A waveform overlaps with Ch_B waveform; (A-B):Subtraction of channel A waveform and channel B waveform RecA:Reload the last waveform saved in Ch_A; RecB:Reload the last waveform saved in Ch_B RecC:Reload the last waveform saved in Ch_C Hide:Hide waveform
	1.0uS—1S(1-2-5sequence step)	Timebase (x-axis voltage per grid)
		Trigger mode: falling edge trigger/ rising edge trigger
	AUTO/NORM/SINGL/ NONE/SCAN/STOP	Auto/Normal/Single/Slow Scan/ Instant Scan/Run/Pause

Getting Started

Power On/Off



- "OFF" Power On/Off Button
- Switch power button to "OFF" to turn off DS212 (If DS212 was powered off automatically, switch off the power button before turning on.)

Turn on/off

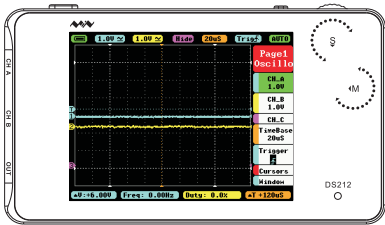

- Normally, turn on DS212, it enters APP1 by default.
- Hold Wheel S and turn on DS212, it enters APP2 (If APP2 is not installed, it enters DFU mode.)

Switch APP

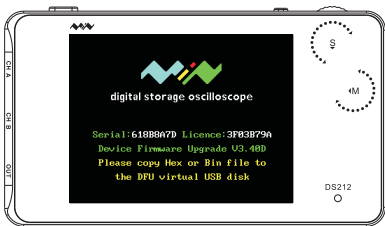

- Hold Pause button "▶||" and turn on DS212, to enter DFU mode.

Upgrade mode

Getting Started

Check up before use

Make a quick inspection of functions to ensure the device is working soundly. Please perform following steps:

- Turn on power and access the homepage of the mini oscilloscope.
- Place in the standard signal (e.g. square wave 1 KHz, $V_{pp}=3V$), insert X1 probe's MCX end to CH A or CH B, and the probe to "OUT". Check if the measurement value and the standard value are equal, calibrate if different. See below for detailed instructions:

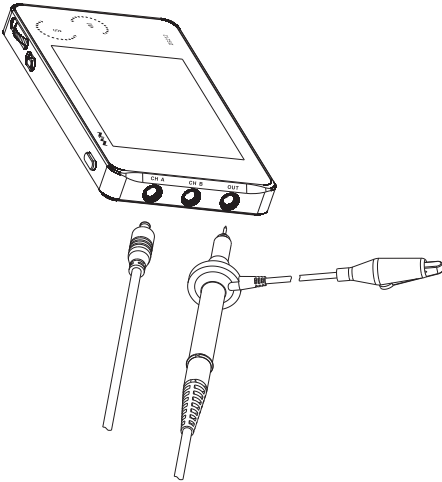

Connect probes to both the MCX and CH A input jacks

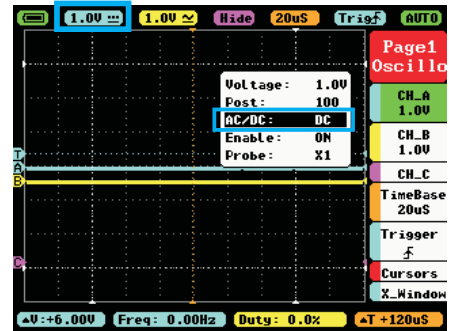

Adjust relevant parameters of CH A:

1. Adjust the DC mode in AC/DC function in CH A
2. Voltage adjustment: Switch Voltage to 1V

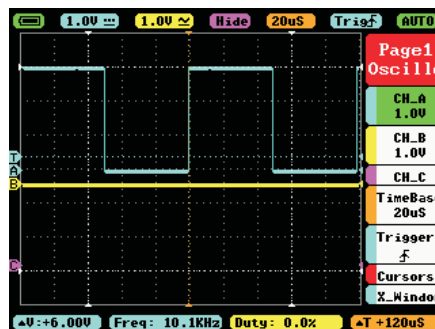

Measure WAVE OUT outlet waveform

Getting Started

Operation Introduction

Switch main menu

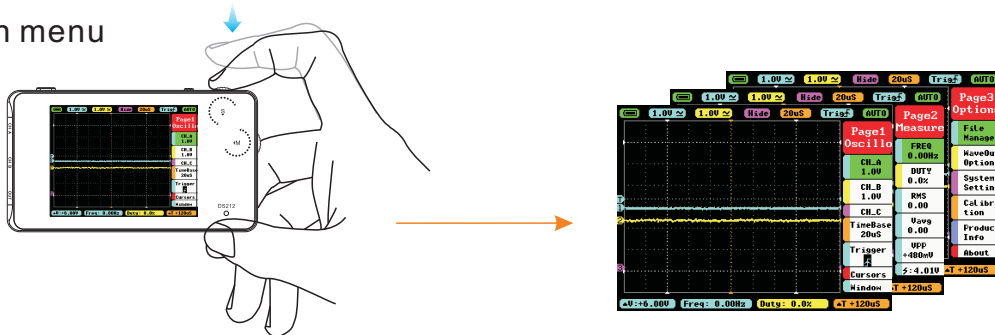

In main menu, middle click Wheel S to switch main menu

Show/Hide main menu

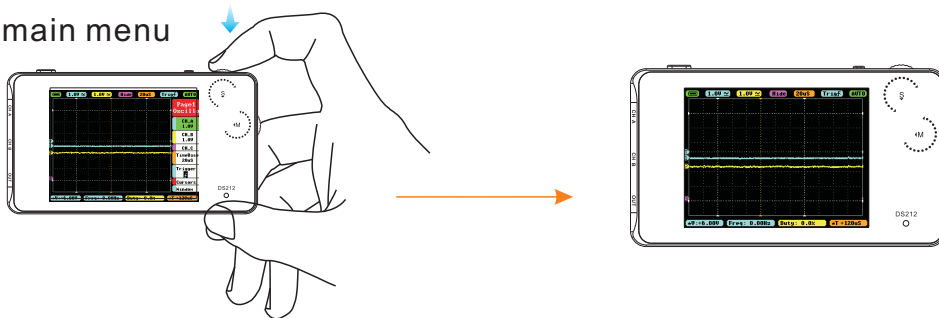

In main menu, hold Wheel S middle button to show/hide main menu

Change time base

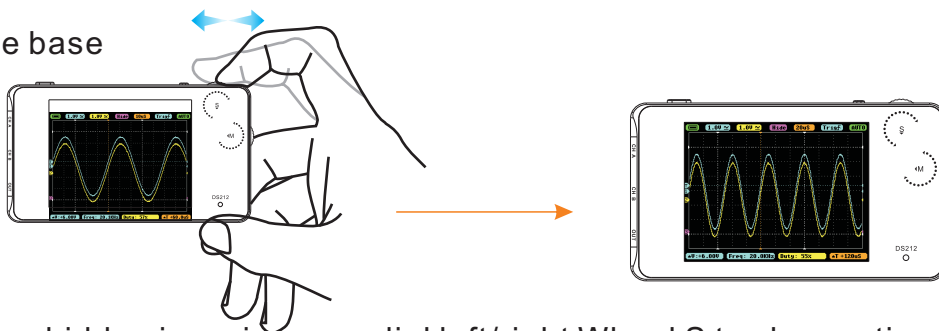

When hidden in main menu, dial left/right Wheel S to change time base
(middle click Wheel S to switch current trigger channel)

Change voltage

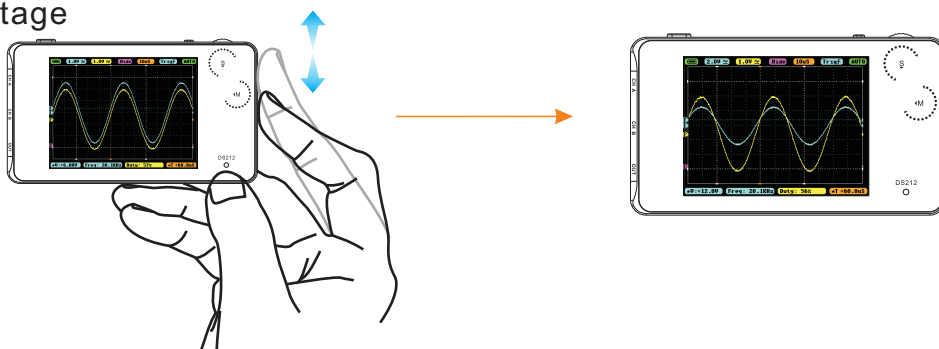

When hidden in main menu, dial up/down Wheel M to change voltage
(middle click Wheel M to switch Channel A/B)

Getting Started

Operation Introduction

Show/Hide sub-menu

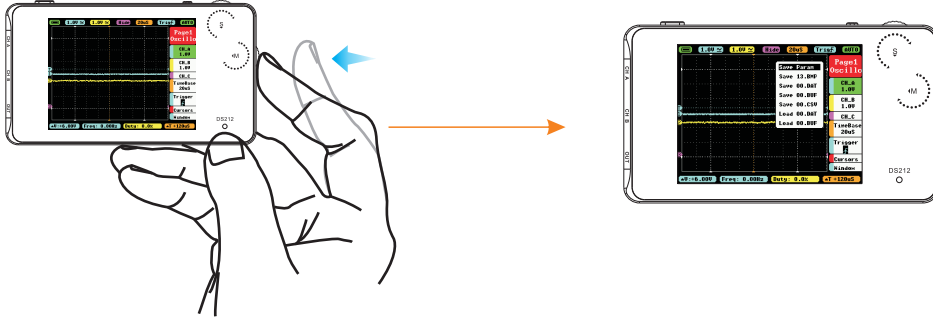

In main menu, middle click Wheel M to show/hide sub-menu

Confirm option

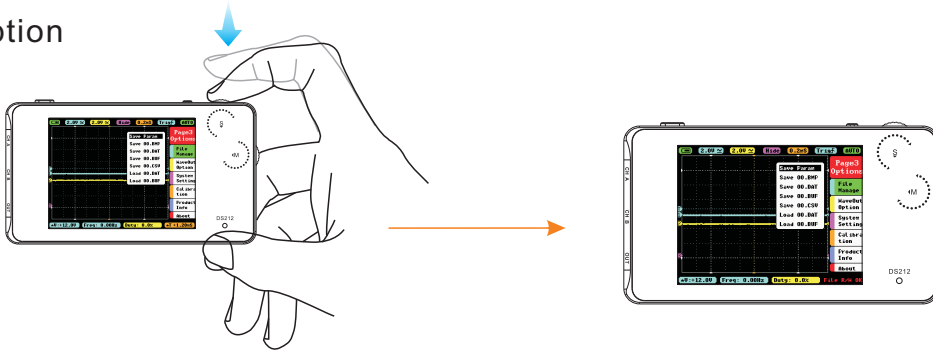

In sub-menu, middle click Wheel S to confirm operation

Choose menu

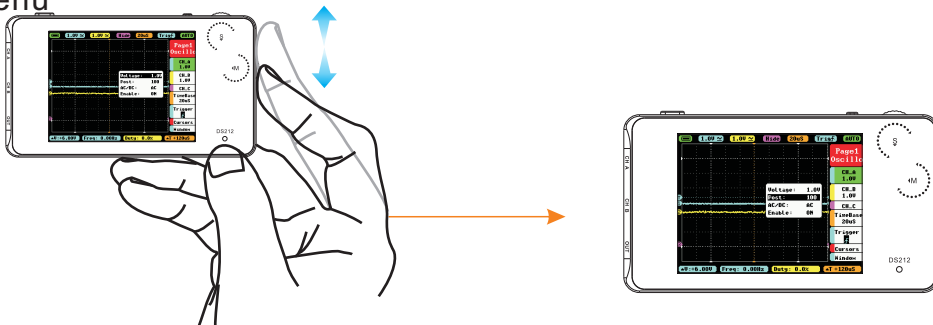

In main menu/sub-menu, dial up/down Wheel M to choose up/down menu options

Getting Started

Operation Introduction

Adjust menu parameters

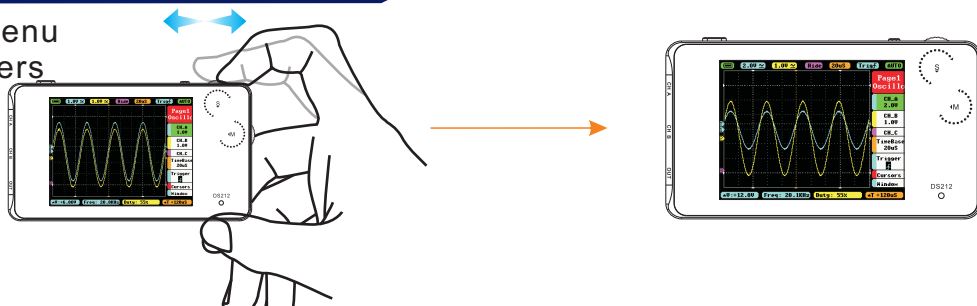

In main menu/sub-menu, dial left/right Wheel S to increase/decrease the setting parameters. (When adjusting parameters of "Post" in sub-menu, hold Wheel S middle button can fast adjust readings)

Show/Hide sub-menu of file management shortcut

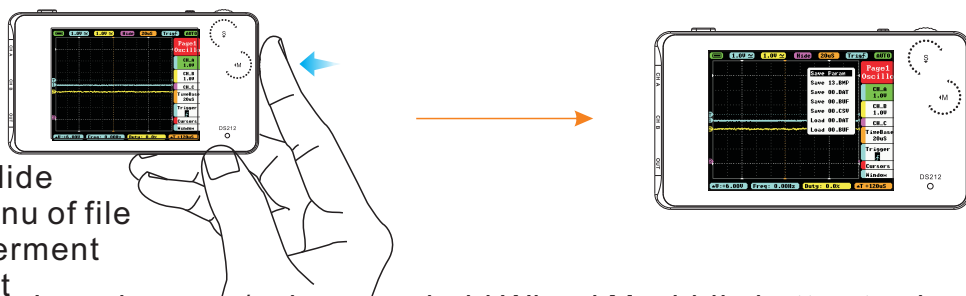

In main menu/sub-menu, hold Wheel M middle button to show/hide sub-menu of file management

"Auto Fit" setting



Enter "Trigger" in "Page 1" of main menu, set "Auto Fit" to "ON", double click Wheel M middle button, DS212 will automatically calibrate amplitude, time base and trigger.

Auto-off setting

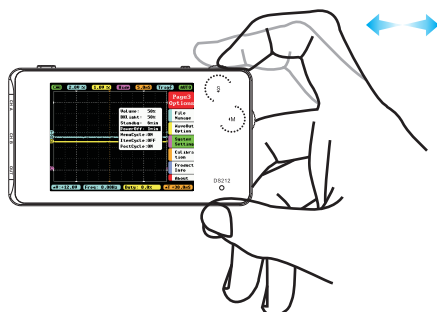

Enter "system setting" of "Page 3" under main menu, choose "Power off", and dial Wheel S left/right to choose the time setting of auto power off. If charging via USB, auto power off will not be activated.

Functional Overview

Overview of Menu options

DS212 Menu

Page1 Oscillo



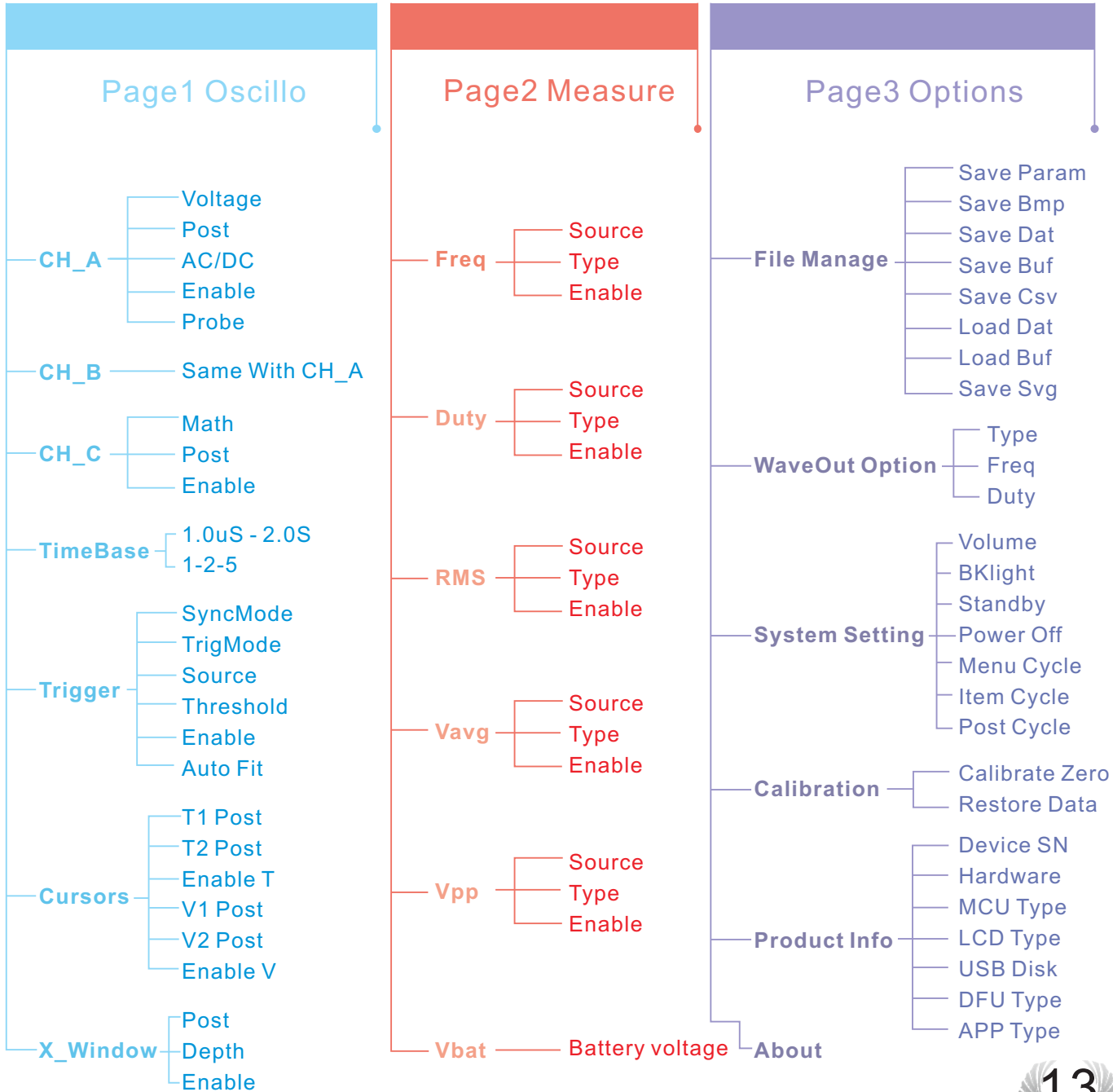

Page2 Measure

Page3 Options





Functional Overview

Specific Parameter Intro

Menu	Options	Functions	Annotation for Functions	Description
Page1 Oscillo Page1 Oscillo		Voltage	Channel A y-axis voltage per grid	20mV/50mV/0.1V/0.2V/0.5V/1.0V/2.0V/5.0V/10V
		Post	Adjust Channel A waveform position upward/downward in the window	Position:5-195
		AC/DC	channel A coupling	AD/DC
		Enable	channel A display/hide	ON/OFF
		Probe		X1 / X10
		Voltage	Channel B y-axis voltage per grid	20mV/50mV/0.1V/0.2V/0.5V/1.0V/2.0V/5.0V/10V
		Post	Adjust Channel B waveform position upward/downward in the window	Position : 5-195
		AC/DC	channel B coupling	AD/DC
		Enable	channel B display/hide	ON/OFF
		Probe		X1 / X10
		Match	Calculation between CH_A waveform and CH_B waveform	-A, -B,A+B,A-B, RecA,RecB,RecC
		Post	Adjust CH_C waveform position upward/downward in the window	Position:5-195
		Enable	CH_C display / hide	ON/OFF
		TimeBase	TimeBase X-axis voltage per grid	1.0us-2.0s(1-2-5 sequence step)

Functional Overview

Specific Parameter Intro

Menu	Options	Functions	Annotation for Functions	Description
Page1 Oscillo Page1 Oscillo		Syncmode	Syncmode trigger mode selection	AUTO/NORM/SINGL/ NONE/SCAN Automatic /standard / single pass /slow scan/ immediate scan
		Trigmode	Choose the Triggering Mode	Rising edge/Falling edge Triggering mode
		Source	Choose the Triggering channel	CH A/CH B
		Threshold	Horizontal Triggering Position Level	Position:-80-110
		Enable	Display/Hide Horizontal Triggering Position Level	ON/OFF
		Auto Fit	Automatic adjustment	ON/OFF
		T1.Post	Time measurement cursor T1	Position : 5-248
		T2.Post	Time measurement cursor T2	Position:5-248
		Enable.T	Display/Hide Time Measurement cursor	ON/OFF
		V1.Post	Voltage Measurement Cursor V1	Site selection : 2-198
		V2.Post	Voltage Measurement Cursor V2	Site selection:2-198
		Enable.V	Display/Hide Voltage Measurement cursor	CH A/CH B/OFF





Functional Overview

Specific Parameter Intro

Menu	Item	Options	Annotation for Functions	Description
Page1 Oscillo	Window	Post	Horizontal movement to view waveform	Depends sample memory depth
		Depth	Internal storage depth	1k/2k/4k/8k
		Enable	Display/hide Trigger line cursor	ON/OFF
Page2 Measure	FREQ 0.00Hz	Source	Choose the Measurement channel	CH A/CH B
		Type	Choose the Measurement Type	FREQ/DUTY/ RMS/ Vavg/Vpp/Max/Min Notes: Frequency/Duty/ Root Mean Square/ Voltage Average/ Voltage Peak-Peak/ Voltage Maximum/ Voltage Minimum
		Enable	Display/Hide measurement window	ON/OFF
	DUTY 0.0%	Source	Choose the Measurement channel	CH A/CH B
		Type	Choose the Measurement Type	FREQ/DUTY/RMS/ Vavg/Vpp/Vmax/ Vmin Notes: Frequency/Duty/ Root Mean Square/ Voltage Average/ Voltage Peak-Peak/ Voltage Maximum/ Voltage Minimum
		Enable	Display/Hide measurement window	ON/OFF

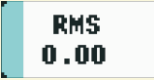
Functional Overview

Specific Parameter Intro

Menu	Options	Functions	Annotation for Functions	Description
Page2 Measure Page2 Measure		Source	Choose the Measurement channel	CH A/CH B
		Type	Choose the Measurement Type	FREQ/DUTY/RMS/ Vavg/Vpp/Max/Min
				Notes: Frequency/Duty/ Root Mean Square/ Voltage Average/ Voltage Peak-Peak/ Voltage Maximum/ Voltage Minimum
	Enable	Display/Hide measurement window	ON/OFF	
		Source	Choose the Measurement channel	CH A/CH B
		Type	Choose the Measurement Type	FREQ/DUTY/RMS/ Vavg/Vpp/Max/Min
				Notes: Frequency/Duty/ Root Mean Square/ Voltage Average/ Voltage Peak-Peak/ Voltage Maximum/ Voltage Minimum
	Enable	Display/Hide measurement window	ON/OFF	
		Source	Choose the Measurement Type	CH A/CH B
		Type	Choose the Measurement Type	FREQ/DUTY/RMS/ Vavg/Vpp/Max/Min
				Notes: Frequency/Duty/ Root Mean Square/ Voltage Average/ Voltage Peak-Peak/ Voltage Maximum/ Voltage Minimum
	Enable	Display/Hide measurement window	ON/OFF	
	Vbat	Battery voltage		

Functional Overview

Specific Parameter Intro

Menu	Options	Functions	Annotation for Functions	Description
Page3 Setting Page3 Options	File Manage	Save Param	Save current parameter settings	Middle click Wheel S to save
		Save Bmp	Save bmp file (waveform image) to the built-in U disk. (Shortcut: long press "Run/Pause" button)	Middle click Wheel S to save
		Save Dat	Save dat file to built-in U disk	Middle click Wheel S to save
		Save Buf	Save buf file (sampling data in buffering area) to built-in U disk	Middle click Wheel S to save
		Save Csv	Save csv file (export sampling data in buffering area) to built-in U disk	Middle click Wheel S to save
		Load Dat	Load dat file	Middle click Wheel S to save
		Load Buf	Load buf file	Middle click Wheel S to save
		Save Svg	Save Svg file (sampling buffer figure)	In U disc
	WaveOut Option	Type	Output signal type	squar/sine/triangle /sawtooth
		Freq	Output signal frequency	Squar(10Hz-1Mhz)sine/ triangle/sawtooth(10Hz-20kHz)
		Duty	Output signal duty cycle	10%-90%
	System Setting	Volume	Adjust buzzer volume	0%-90%
		Blight	Adjust backlight brightness	10%-100%
		Standby	Adjust standby time	0min-60min

Functional Overview

Dial up/down Wheel M to choose options in option menu, middle click Wheel M to open option setting menu; dial left/right Wheel S to choose parameters and change current values.

Specific Parameter Intro

Menu	Options	Functions	Annotation for Functions	Description	
Page3 Setting Page3 Options	System Setting	PowerOff	Auto power off time	0min-60min	
		MenuCycle	Main Menu option cycle	ON/OFF	
		ItemCycle	Sub-menu option cycle	ON/OFF	
		PostSlide	Ripid Slide post	ON/OFF	
	Calibra tion	Calibrate Zero	Middle click Wheel S, an auto calibration window will pop up, middle click Wheel S to auto calibrate; after auto calibration, save calibration data in the pop-up window		
		Restore Data	Middle click Wheel S, a restore factory setting window will pop up, then middle click Wheel S to restore factory settings		
	Product Info	DeviceSN	device serial number		
		Hardware	Hardware version number		
		MCU Typy	Processor type		
		LCD Typy	LCD screen mode		
		USB Disk	U Disk capacity		
		DFU Typy	DFU version		
		APP Typy	APP version		
About	Relevant ancillary information				

Product Inspection

Charge and monitor the battery



- When the battery voltage status turns to “” or display brightness is relatively dim, please charge the battery in time. Charging is available in both power-on and off mode. When the battery is being charged, the LED will light on until the charging process is finished.
- Under any circumstances, switching power button to OFF can turn off DS212.

General Inspection

- When you get a new DS212 oscilloscope, you are advised to inspect the product by the following steps.
- Inspect damages caused by shipping.
If the packaging carton or the protection pad is seriously damaged, keep the package until the oscilloscope & accessories pass the electrical and the mechanical test.
- Inspect the product.
Please contact the company if the following problems occur:
 - 1) product surface is damaged,
 - 2) product doesn't work properly,
 - 3) product does not pass performance test.If the damage is resulted from shipping, please keep the package and contact the company for repair or exchange.

Battery Disposal

Regulatory Markings



FCC compliance statement

This device is complied with the regulation in the 15th part of FCC regulation. Operation is subject to the following two conditions:

- (1) This device may not cause harmful interference, and
- (2) This device must accept any interference received, including the interference that may cause undesired operation.



The CE mark is a registered trademark of European Community. This CE mark shows that the product complies with all the relevant European Legal Directives.



Do not dispose in domestic household waste

- This device complies with the WEEE Directive (2002/96/EC) marking requirement. This affixed product label indicates that you must not discard this electrical or electronic product in domestic household waste.
- Disposal and recycling: you must dispose the mini oscilloscope according to local law and regulations. As the oscilloscope contains electronic building brick and battery, you must dispose it respectively with garbage.
- Please dispose the battery in accordance with local environmental regulations.

Firmware upgrading

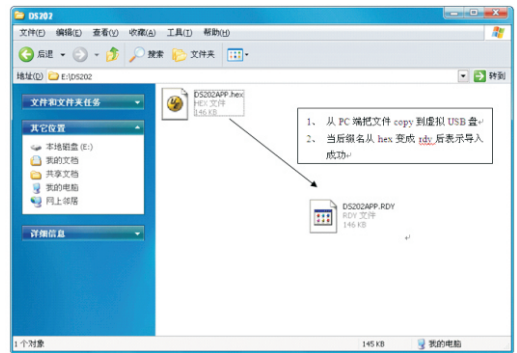
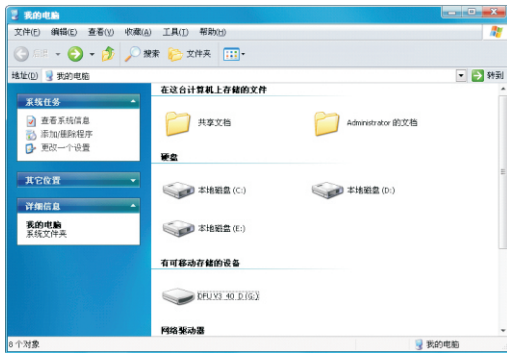

To upgrade the firmware of oscilloscope, please carry out the operation below:

1. Open web browser to visit www.minidso.com, download the newest firmware appropriate to oscilloscope to your PC.
2. Hold Pause button and turn on DS212, to enter DFU mode for upgrade.
3. Use USB data cord to connect DS212 to your PC, and a removable hard disk named "DFU V3_40_D" will appear on your PC. Copy the hex firmware to the root directory of that disk. After the extension of the firmware changes from "hex" to "rdy", restart DS212. Then the upgrading process is finished.

For more information, please visit www.minidso.com.